

A-DRY 6-200

Heatless adsorption compressed air dryers





Four individually controlled valves

To provide optimal control over the complete drying process four high quality solenoid valves are used.

Individual control of each valve results in column switch-over without any pressure peaks.

Compact control blocks

Due to compact design of upper and lower control block, check valves and purge air nozzles are integrated in the robust block which results in a reliable operation and easy replacement during service procedure.

Manometers

Two manometers positioned on top of the upper control block give reliable information about the pressure inside of each column. In combination with LED indication on the controller, manometers are an excellent tool for diagnostics.

Removable dessicant column

Only two screws are necessary to release the dessicant column. Replacement of the dessicant media has never been so quick and easy - you save your valuable time and money.

BACKGROUND

Compressed air contains contaminants such as water, oil and particulates which must be removed or reduced to the acceptable level based on specific application requirements.

Standard ISO 8573-1 specifies air purity/quality classes for these contaminants. Humidity (water vapour content) is expressed in the terms of Pressure Dew Point (PDP) where Dew point is the temperature at which air is 100% saturated with moisture.

When the temperature of the air decreases to or below the dewpoint, condensation will occur. Reduction of water content down to pressure dew point +3°C is usually achieved with refrigerant dryers while for lower pressure dew points adsorption (also called desiccant) dryers are typically used.

ADSORPTION DRYER

Typical applications for the adsorption dryers are outdoor installations where the risk of freezing occurs and applications with high quality requirements in terms of air dryness (PDP < +3°C) such as the process air in process industry (food and beverage, pharmaceutical, electronic, chemical, ...).

The most common adsorption dryers are heatless regeneration adsorption dryers due to their simplicity reliability and relatively low investment costs.

CONTROLLER

A-DRY adsorption dryer series controller interface in combination with the tower pressure indicators enables complete monitoring of the adsorption dryer operation. Interface includes six LED diodes, one LED for power, one LED for alarm/stand by status and four LED diodes for control valves monitoring.

Each of the control valve monitoring LED diodes shows the status of one of the control valves. By consulting the legend on the interface it is possible to determine the exact configuration of the valves at any given time.

This information together with the information from tower pressure indicators enables monitoring and analysing of the adsorption dryer operation, as well as improves the troubleshooting.

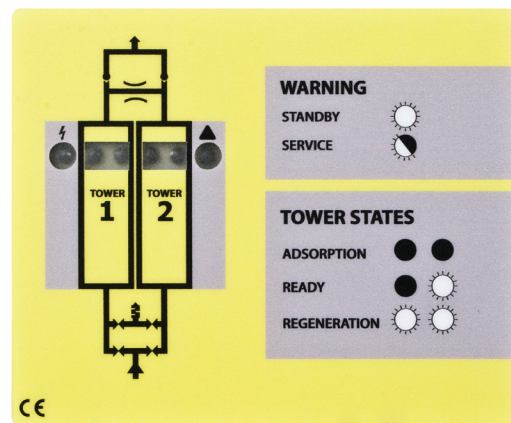

High quality two layer desiccant bed

A-DRY dryers are filled with a high quality robust desiccant which results in a stable operation with a low energy input for the regeneration. Primary desiccant is a molecular sieve with an extremely high drying potential. Lower part of the column is filled with a water resistant silica gel.



Spring fixed desiccant bed

Movement of the desiccant causes abrasion and channelling which results in decrease of the drying efficiency. Therefore every A-DRY column is equipped with a spring which provides constant force on the desiccant bed thus assuring uniform distribution of beds without any movement during operation.

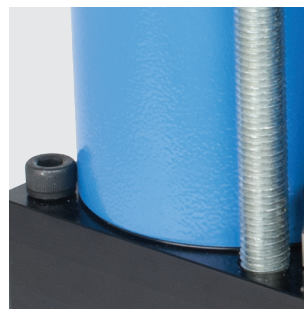

Surface protection

The columns and the cover sheet metal parts are epoxy powder painted while all the other aluminium parts are anodized to prevent any potential oxidation.

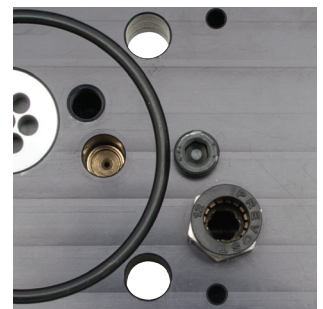

Precise CNC machining of components

Contemporary CNC machining assures high quality, perfect tightening and reliable operating of all dryer components. B

uilt-in high-quality materials guarantee the smooth operation of the unit.

Components

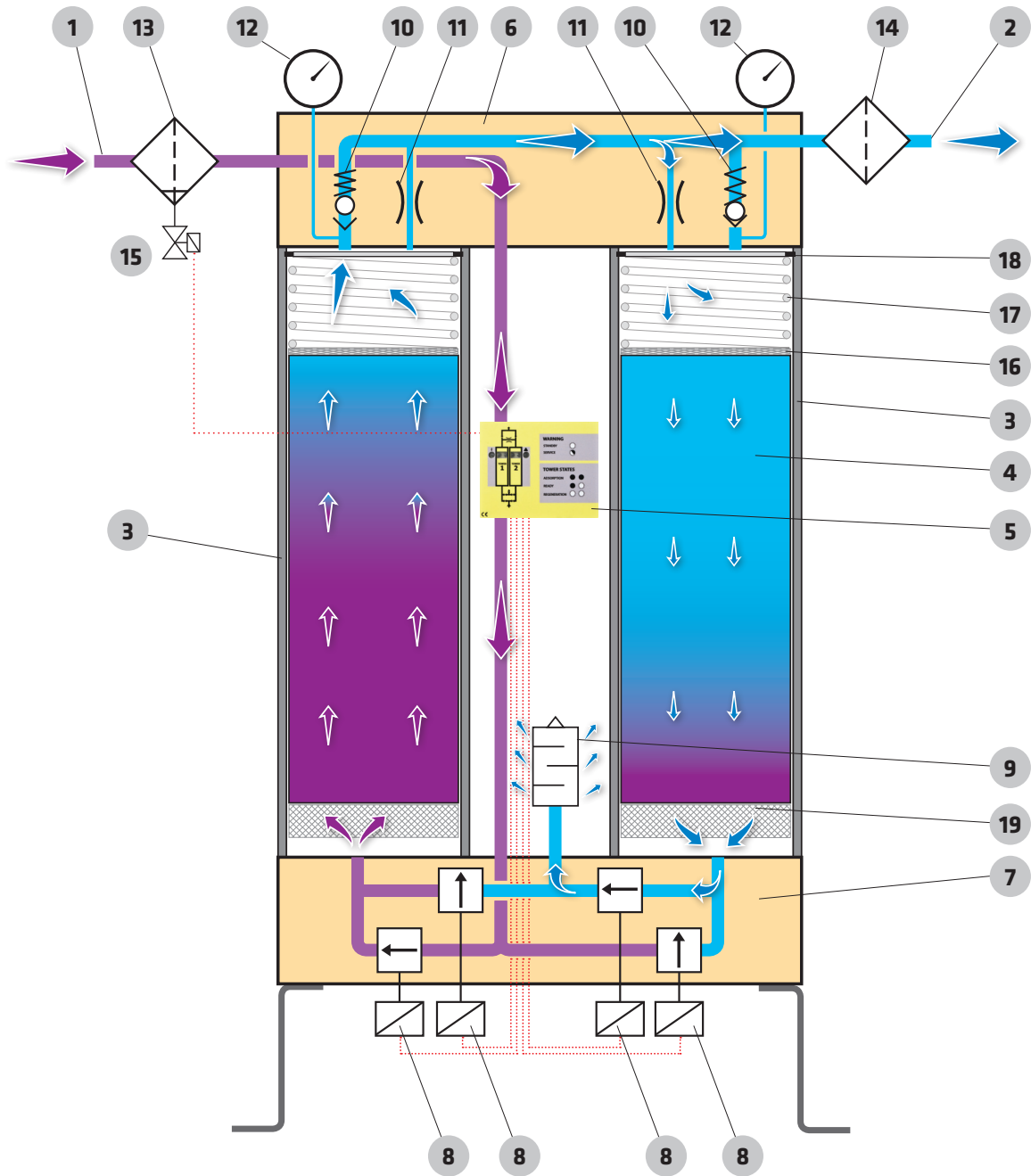

A-DRY adsorption dryers have been designed for continuous separation of water vapour from the compressed air thus reducing the pressure dew point.

Compact A-DRY series dryer consists of upper and lower control block, controller with LED display and two alternately operated columns filled with desiccant.

Adsorption takes place under pressure in the first column while the second column regenerates with a portion of already dried compressed air at the ambient pressure.

When the first column is saturated to a certain level column switch-over is carried out and the process of adsorption continues in the second column without any drop of pressure at the outlet of the dryer.

Regeneration of the saturated desiccant is possible because a small portion of already dry compressed air is decompressed and when expanded it becomes extremely dry.

This portion of extremely dry decompressed air also called "purge air" is then fed through the saturated column in the reverse flow direction in order to remove the adsorbed water molecules from the desiccant and release them back to the ambient.

Energy saving

A-DRY series adsorption dryers have an option to receive a stand-by signal from the compressor or other compressed air supply. While in the stand-by the air can flow freely through both towers in direction from the inlet to the outlet of the adsorption dryer. Meanwhile the adsorption dryer controller is in the stand-by mode and ready to resume with the normal operation as soon as it gets the appropriate signal. The stand-by signal is relayed to the A-DRY adsorption dryer through a stand-by contact on the controller by a connected switch.

10 min operating cycle

A-DRY energy losses have been optimized due to 10 minute operating cycle:

- 5 min = Adsorption
- 4 min = Regeneration
- 1 min = Pressure build up

Extended operating cycle with 12 switch overs per hour also reflects in less wear and thus in a more reliable operation.

- 1 Compressed air inlet (wet air)
- 2 Compressed air outlet (dry air)
- 3 Column filled with dessicant
- 4 Two layer desiccant bed
- 5 Controller
- 6 Upper control block
- 7 Lower control block
- 8 Electromagnetic valve
- 9 Air silencer
- 10 Non-returning valve
- 11 Nozzle
- 12 Pressure manometer
- 13 Inlet air filter
- 14 Outlet air filter
- 15 Condensate drain
- 16 Stainless steel mesh
- 17 Spring
- 18 Safety ring
- 19 Stainless steel mesh

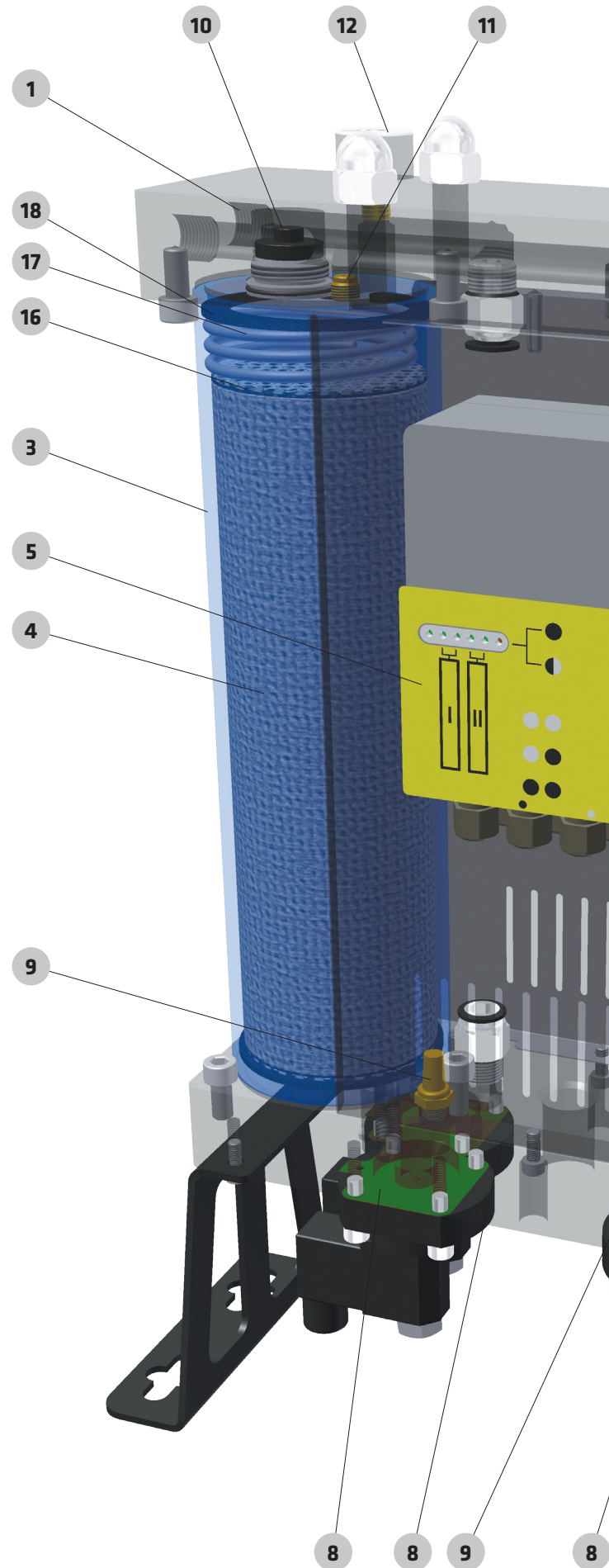

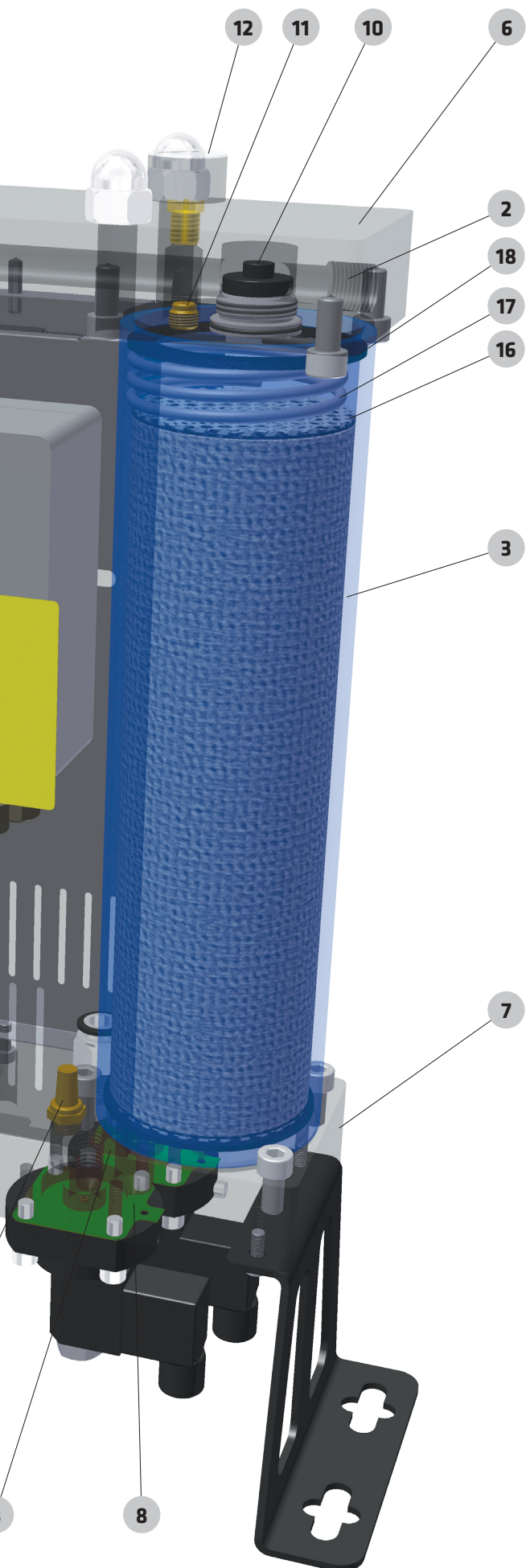

Easy maintenance

Due to innovative column design desiccant replacement can be done in a few minutes. Complete column can be removed from the dryer just by releasing four top nuts and by removing side locking screws. Column can then be refilled or completely replaced with a new one.

When the column is removed clear access to the check valve and the purge nozzle is available without the need to completely dismantle adsorption dryer.

Valves and membranes are located underneath the lower control block and can be accessed and replaced in a quick and easy way.



- 1** To remove column unscrew two side locking screws (one from the upper and one from the lower control block).
- 2** Unscrew the four locking nuts from the upper control block.
- 3** Remove the column and replace the desiccant bed.

Technical data

TECHNICAL DATA A-DRY 6-200

Type	Connection IN/OUT	Nominal volume flow		Dimensions						Mass kg
		Inlet ¹	Outlet ²	A [mm]	A* [mm]	B [mm]	B* [mm]	C [mm]	C* [mm]	
	"	[Nm ³ /h]	[Nm ³ /h]							
A-DRY 06	G3/8"	6	4,7	339	404	288	552	100	120	10,5
A-DRY 12	G3/8"	12	9,4	573	638	288	552	100	120	13,5
A-DRY 24	G3/8"	24	18,8	1041	1106	288	552	100	120	19,0
A-DRY 36	G3/8"	36	28,2	1509	1574	288	552	100	120	27,5
A-DRY 60	G1/2"	60	47,0	1041	1106	370	634	148	170	45,0
A-DRY 75	G1/2"	75	58,8	1275	1340	370	634	148	170	53,0
A-DRY 105	G1/2"	105	61,8	1743	1808	370	634	148	170	70,0
A-DRY 150	G1"	150	88,3	1345	1455	440	815	198	240	170,5
A-DRY 200	G1"	200	117,7	1538	1648	440	815	198	240	182,2

Operating pressure range	4 to 16 bar
Operating temperature range	+1,5 °C to +50 °C
Pressure dew points	-25 °C / -40 °C / -70 °C
Voltage, frequency	230V, 50/60 Hz
Power consumption	<30 W
Protection class	IP 65
Filter (inlet)*	super fine - 0,01 µm
Filter (outlet)	dust filter; 1 µm

⁽¹⁾ Refers to 1bar(a) and 20°C at 7 bar operating pressure, inlet temperature 35°C and pressure dew point at outlet -40°C.

⁽²⁾ Outlet flow refers to typical assumption during regeneration phase for operating at nominal inlet flow conditions. Outlet flow includes average air losses of approximately 17,3 %.

* If dryer is supplied without inlet filter compressed air class 1 (ISO 8753-1) for solid particles and oil should be provided to the inlet of the dryer.

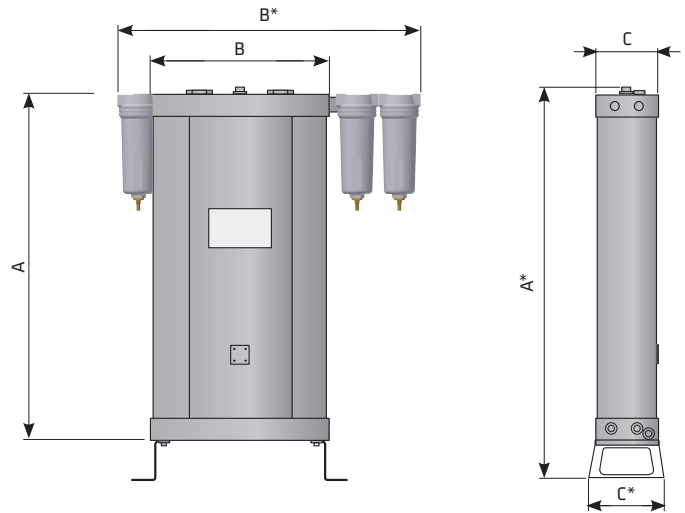

CORRECTION FACTORS - F1

Operating pressure [bar]	2	3	4	5	6	7	8	9	10	11	12	13	14	15	16
Operating pressure [psi]	29	44	58	72	87	100	115	130	145	160	174	189	203	218	232
Correction factor	0,38	0,5	0,63	0,75	0,88	1	1,13	1,25	1,38	1,50	1,63	1,75	1,88	2,00	2,13

CORRECTION FACTORS - F2

Inlet temperature [°C]	25	30	35	40	45	50
Correction factor	1,00	1,00	1,00	0,97	0,87	0,80

DEW POINT

[°C]	-25	-40	-70
C _D	1,1	1	0,7

OMEGA AIR

Better air



OMEGA AIR d.o.o. Ljubljana

T +386 (0)1 200 68 00
F +386 (0)1 200 68 50

info@omega-air.si

Cesta Dolomitskega odreda 10
SI-1000 Ljubljana, Slovenia
www.omega-air.si

OMEGA AIR GmbH

T +49 (0) 2841 / 39399-57
F +49 (0) 284 / 39399-66

uwe.ohletz@omega-air.de

Eurotec Ring 15
D-47445 Moers, Deutschland
www.omega-air.de

OMEGA AIR Zagreb d.o.o.

T +385 (0)1 2371 / 872
F +385 (0)1 2371 / 870

info@omega-air.hr

Aničeva 13A
HR-10000 Zagreb, Croatia
www.omega-air.hr

